

# INSTALLATION INSTRUCTION

WKDPL02DCCDD-EE  
(1 year)

WATER EFFICIENT TAPWARE  
(NOMINAL FLOW RATE = 7.5 L/min)

## Pressure & Temperature Requirement

- \*Hot and cold water inlet pressures should be equal
- \*Inlet pressure range : 150 ~ 1000 kPa
- \*Maximum hot water temperature : 80 °C

## Important Notice Of Routine Maintenance And Care

- Occasional cleaning of aerator is recommended.
- Use of soapy water and a soft sponge or cloth is recommended.
- Avoid cleaning with chemicals, solvents, or harsh detergents. (THIS MAY SERIOUSLY HARM SURFACE AREA)
- If used with hard water or water with very high mineral content, it is absolutely necessary to clean and dry the tapware immediately after every use. (CALCIUM AND OTHER MINERALS COULD SERIOUSLY DAMAGE SURFACE AREA)
- Please wipe the canopy and keep your hands dry before installing or replacing the battery of the LED to prevent the LED circuit board from water or moisture damage.
- When installing with filtration system with carbon filters or changing carbon filters, it's suggested to flush the filtered tubes from the system before connecting with the tapware to prevent possible carbon dust contamination into tapware cartridge to cause leaking.

## Battery Installation Steps

1 Install battery.

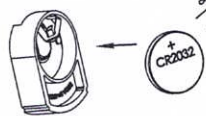

2 Reset: When installing or replacing battery, it will flash yellow light three times.



3 Install into tapware canopy. The slotted end must be oriented toward the tapware.

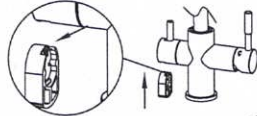

4 Open filtered water with blue signal 5 times only.

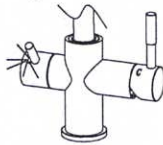

## LED Indicator

1. Blue light will flash at operation after the battery is installed. It will flash red light when it has been activated over 1 year.
2. When it flashes red light, please change your filter and battery at the same time.
3. Program 365 days (1 year) : LED signal for activating 1 year is flashing YELLOW 3 times. At the beginning flashing BLUE, 355 days flashing YELLOW, 365 days total time flashing RED.
4. Accumulation of days records once per hour.
5. PCB RESET: Press for 5 seconds until flashing Red - Blue - Red.

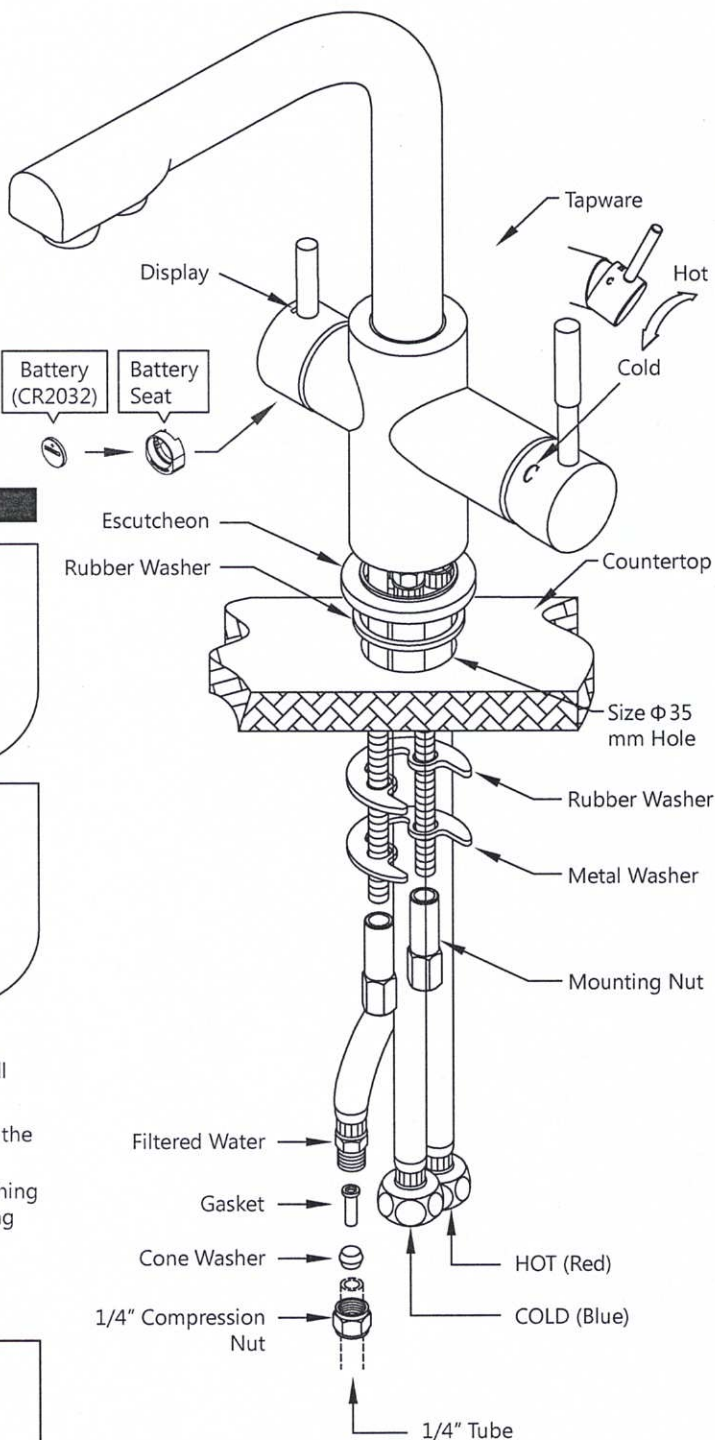
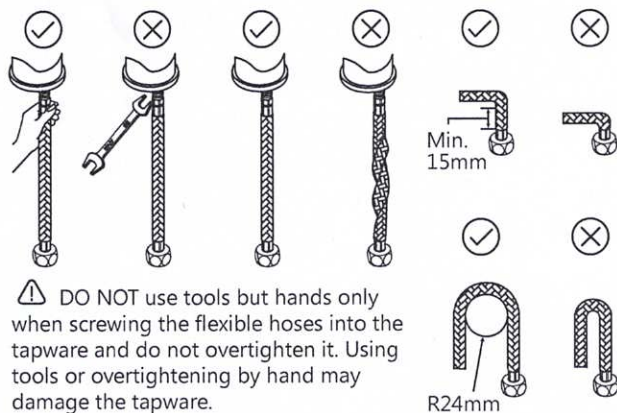

## Bottom View

