

WARNING: For correct operation & installation, it is essential to observe these instructions

TWIN & TRIPLE UNDERSINK WATER FILTRATION SYSTEM



Important Notice: Please remember to document your service schedule on page 22 of this booklet for easy reference and maintenance tracking. Your diligent record-keeping ensures timely and efficient maintenance, guaranteeing the longevity and optimal performance of your filtration system.

CONTENTS

Twin & Triple Undersink Water Filtration System 1

Installation and Operation Manual..... 3

 AquaCo Customer Service..... 3

 Operation 3

 Installation 4

 Installation requirements 4

System Dimensions 4

Typical Installation 5

 Components..... 5

 Installation Procedure..... 6

Cartridge Installation/Maintenance..... 7

Fluoride Filter Pre-Flush..... 9

Faucet Installation Procedure 11

 Battery Installation..... 12

 Battery Replacement & Reset..... 12

 Led Light Indicator 13

 Faucet Maintenance and Care 13

Guide to use Push-In Tube Connectors..... 13

Use Guidelines 14

Cartridge Replacement Guide For Twin Undersink Systems 15

Cartridge Replacement Guide For Triple Undersink Systems 16

 Performance Data Sheet..... 17

Notes..... 18

Warranty 18

Price 20

Default 20

Severence 20

Warranty/Australia..... 21

Service Schedule 22

INSTALLATION AND OPERATION MANUAL

AQUACO CUSTOMER SERVICE

Thank you for purchasing an AquaCo undersink water filter system. Your system is a proven performer manufactured from only quality materials and components and will give years of 'spring fresh' water free of impurities if maintained properly.

Caution: Do not use with water that is microbiologically unsafe or with water of unknown quality without adequate disinfection before or after the system.

The system is designed for metropolitan supply water but can be used in other situations. For other types of water supply please contact your local AquaCo stockist or call our AquaCo Customer Service Helpline.

The AquaCo filter systems cartridges need replacing regularly to maintain optimum performance. This is a simple procedure when following instructions. For cartridge replacements contact your nearest AquaCo stockist.

Customer Service Helpline 1300 70 1300 (Australia).

OPERATION

The AquaCo undersink systems are designed to run economically for many years, dependent on the initial installation and periodical maintenance.

Flush systems for 10 minutes after any period of non-use more than 2 days. For a period of non-use of 2 weeks or more, it may be necessary to replace cartridges.

This product must be installed in accordance with local plumbing regulations by a licensed plumber.

Installation Note:

1. If chosen an option with a fluoride filter, the fluoride filter is pre-flushed in our assembly area for the installer convenience. However, when changing the filters in the future, please follow the instructions in page 9.

2. A water filter system/tap, like any product, has a limited life and may eventually fail. Also, sometimes failure happens early due to unforeseen circumstances. To avoid possible property damage, this product should be regularly examined for leakage and/or deterioration and replaced when necessary. A drain pan, plumbed to an appropriate drain or outfitted with a leak detector, should be used in those applications where any leakage could cause property damage, and/or the water supply should be turned off if no one is home/present.

INSTALLATION MUST BE COMPLETED BY A LICENCED PLUMBER. FAULTY OPERATION DUE TO UNQUALIFIED PERSONS WILL RESULT IN VOIDED WARRANTY COVERAGE.

INSTALLATION

This system comes complete with an installation kit enabling it to be connected to 15mm (½") copper pipe (cold supply only - hot water should be filtered prior to heating). Included is a control valve incorporating backflow prevention, anti hammer, flow control and pressure limiting capabilities in full compliance with the relevant laws.

INSTALLATION REQUIREMENTS

1. 13 mm (½") Cold water line.
2. Min/Max pressure: 240 - 520 kPa.
3. Min/Max temperature 0° - 30°C (protect from freezing).
4. Suitable location for faucet.

Alternative fittings may be required if being connected to anything other than 15mm (½") copper pipe. No electrical or drainage requirements needed.

SYSTEM DIMENSIONS

- **Twin** Undersink System Dimensions: 270 W x 370 H x 130 D (mm).
- **Triple** Undersink System Dimensions: 390 W x 350 H x 130 D (mm).
- **Dedicated Tap** Dimensions: 80 W x 130 D x 292 H (mm).

Note: Instead of having a separate faucet for filtered water, consider having a 3 Way Mixer to avoid drilling a hole through your stone/wood bench.

TYPICAL INSTALLATION

Figure 1

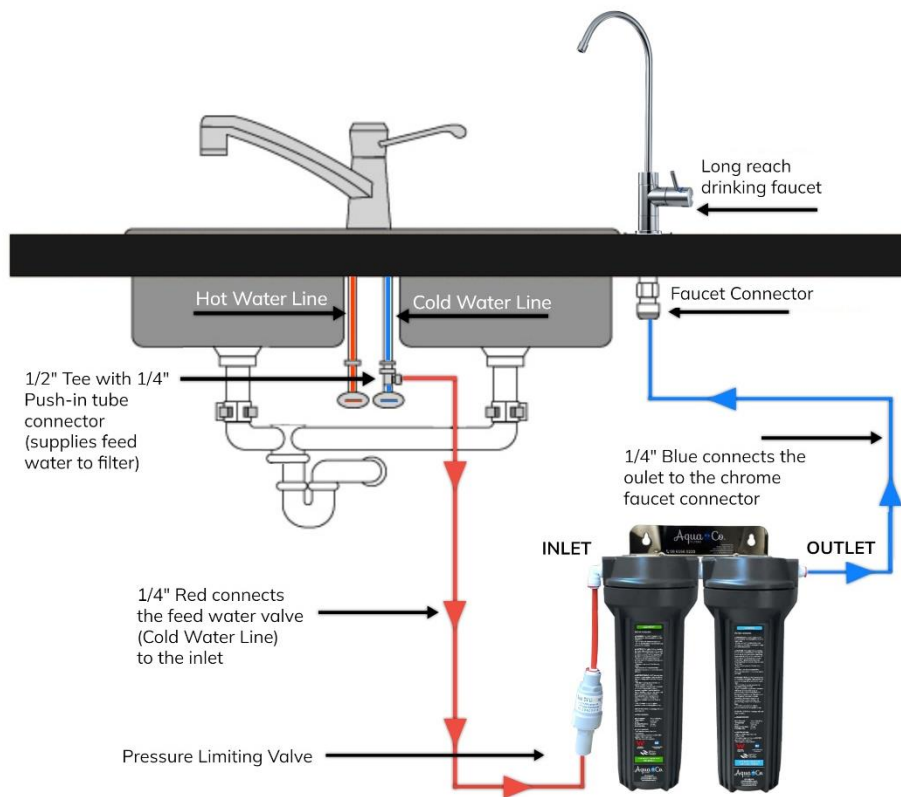

COMPONENTS

1. Angle stop valve (Not included)
2. 1/2" Tee with 1/4" Push-in Tube Connector
3. 1/2" Braided Cold-Water Hose (Not included)
4. 1/4" Flexible Red Tubing to Water Filter
5. 350 kPa PLV Pressure Limiting Valve with Dual Check Valve Built-in
6. Housing Sump with 1st Stage Filter (Sediment or Fluoride Pre-Filter)
7. Housing Sump with 2nd Stage Filter (Carbon or Aragon Filter)
8. Housing Sump with 3rd Stage Filter (For Triple Undersink Water Filters)
9. Elbow Connector 1/4" Tube to 1/4" Male
10. Straight Adaptor 1/4" Male to 1/4" Tube
11. Stainless Steel Bracket
12. 1/4" Flexible Blue Tubing to Faucet
13. JG 1/4" Tube to 7/16" Female to Faucet
14. High Loop Faucet with LED Indicator

INSTALLATION PROCEDURE

1. **Find a convenient location:**
 - a. Twin Undersink System Dimensions: 270 W x 370 H x 130 D (mm),
 - b. Triple Undersink System Dimensions: 390 W x 350 H x 130 D (mm),
 - c. Tap Dimensions: 80 W x 130 D x 292 H (mm).
2. **Shut Off the water supply:** Locate the connection between the kitchen tap & cold-water line (Usually a flex line). Shut off the incoming water and open the tap (cold water) to release the pressure.
3. Disconnect the **cold water** braided hose.

Note: If you do not know which one is the hot or cold, run the hot water for a while and feel the hoses.
4. **Install the Mains Connector or Isolation Valve:** From the **cold-water inlet**, install the valve adaptor/mains connector in between. **DO NOT** apply thread tape to these connections as they are designed to use the washers only.

Figure 2



Figure 3

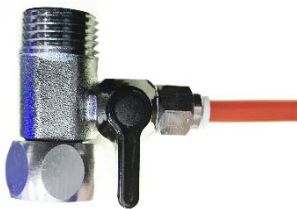

5. **Connect 1/4" RED tube to Mains Connector or Isolation Valve.** Push the red tubing straight into the fitting until it reaches the tube stop. Then, secure with the red clip.
6. **Check for leaks:** With the black handle facing in line with the cold-water line (Fig 3) the valve is in the off position. During this point, you can turn your water supply back on to check for leaks in the valve installation.
7. **Select location on kitchen sink to install faucet.** Make sure there is adequate access under the bench top for the hoses. The faucet supplied with the system requires a **1/2" hole or 12.5mm hole**. Use a centre punch to locate the position to drill.
8. Drill a pilot hole and gradually enlarge until you have the correct size hole.

9. To install faucet, **insert the faucet into the hole in sink or bench**. The faucet may be installed on any flat surface over 50mm (2") in diameter. (Remember: check the underside of the location for interference). Make a small indent using a centre punch to mark the desired drilling location. Drill a pilot hole with a metal drill. Enlarge the hole using a 1/2" metal drill bit.
10. Once the hole has been drilled install the faucet as per Figure 5 on Page 11. Be sure the faucet body, chrome plate, and the black rubber washer are placed above the sink. Install the black locating washer, the lock washer and nut underneath, then tighten firmly while aligning faucet in the desired direction. **Connect BLUE tube to faucet.**

Figure 4

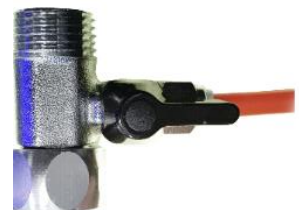

11. **Reset LED indicator by following instructions on page 12.**
12. Install housing assembly by positioning it in the desired location, marking the position of fixing holes and fixing with mounting screws. Allow room for the connecting tubes and for removing the filter sumps (50 mm).
13. Fit tubing into connectors (for quick-connect fittings see fig 6 on page 13). Allow slack in the tubing. Make sure flow is right according to inlet outlet on housing assembly. For faucet connection see figure 5.
14. Install cartridges as per cartridge installation/changeout on page 7.
15. Restore the water supply and check for leaks. The filters need to be only hand tight. If they leak then undo housing and check the O-ring is seated properly.
16. Run the system for at least 10 minutes to remove carbon fines. **Water may appear milky, but this is normal and is only tiny air bubbles that will clear after a short period.**

CARTRIDGE INSTALLATION/MAINTENANCE

Proceed to Page 9 if you have a fluoride removal filter. Otherwise, please continue reading the following information.

To change the filter cartridges, adhere to the following procedure.

1. CLOSE ISOLATING VALVE - Locate your isolating valve connected to your cold-water supply. Turn isolating valve OFF to prevent water flow.



2. OPEN DRINKING TAP - Go to your drinking faucet and open the tap to release the pressure.



3. OPEN THE HOUSINGS - Loosen the housings, using the spanner supplied and unscrew filter housing sumps.



4. REMOVE CARTRIDGES - When opening the housing, place a container underneath to catch any spillage. Cleanse the inside of the housing using warm water.



5. INSTALL NEW CARTRIDGES - Drop in new filter in the same housing WITH PACKING REMOVED. When installing the new filter, please double check that the new filter and the current filter have the same specifications.



6. CHECK O-RING & FILTER - Lubricate with food grade silicone lubricant or similar if needed. Replace O-ring if kinked or damaged (Part No: ORG-STD). It is very important the filter and O-ring are seated properly in the housing.



7. CLOSE THE HOUSINGS - Screw in housing sump. Tighten the housing using the spanner supplied.



8. REPEAT PROCEDURE - Repeat procedure from step number #3 until all filters have been changed.



9. OPEN ISOLATING VALVE - Locate your isolating valve connected to your cold-water supply. Turn isolating valve ON to allow water flow.



10. KEEP DRINKING TAP OPEN - After installing cartridges KEEP DRINKING TAP OPEN to flush unit for 5 - 10 minutes. During this time, check for any visible drips or leaks from connections and fittings. Then, close it.



Water may appear milky, but this is normal and is only tiny air bubbles that will clear after a short period.

11. RESET LED INDICATOR - Reset LED indicator by following instructions on page 12.



12. CHECK FOR LEAKS – Check for leaks rectifying any before leaving the unit. Ensure that all the connections, fittings, and housings have been tightened properly.



Since new filters have been installed, pay special attention to the gap where the housings seal.

13. IF LEAKS OCCURR - If you find any drips or moisture, mark the location. This will help you locate the issue if you need to shut off the water and drain the system for repairs.

14. REMEDIATION - If you detect a leak, shut off the water supply to the twin undersink system immediately.



15. TIGHTEN HOUSINGS, FITTINGS OR CONNECTIONS - If tightening doesn't stop the leak, you may need to replace the faulty component or fitting, or consider using plumber's tape for threaded connections. If this occurs, please contact us on 1300 70 1300.



16. FINAL CHECK - Once you have addressed any issues, turn the water supply back on and monitor for another 1-2 hours to ensure that there are no further leaks.



FLUORIDE FILTER PRE-FLUSH

To change the filter cartridges, adhere to the following procedure.

1. CLOSE ISOLATING VALVE - Locate your isolating valve connected to your cold-water supply. Turn isolating valve OFF to prevent water flow.



2. OPEN DRINKING TAP - Go to your drinking faucet and open the tap to release the pressure.



3. OPEN ALL HOUSINGS - Loosen the housings, using the spanner supplied and unscrew filter housing sumps.



4. REMOVE ALL CARTRIDGES - When opening the housings place a container underneath to catch any spillage. Cleanse the inside of the housing using warm water.



5. INSTALL NEW FLUORIDE FILTER ONLY - Drop in new filter in the corresponding housing (1st Housing for Twin Undersink Systems and in the 2nd Housing for Triple Undersink Systems) WITH PACKING REMOVED. When installing the new filter, please double check that the new filter and the current filter have the same specifications.



6. CHECK O-RING & FILTER - Lubricate with food grade silicone lubricant or similar if needed. Replace O-ring if kinked or damaged (Part No: ORG-STD). It is very important the filter and O-ring are seated properly in the housing.



7. CLOSE ALL HOUSINGS - Screw in housing sump. Tighten the housing using the spanner supplied. **Leave the second housing EMPTY.**



8. TURN ON THE WATER - Let water flow through the water filter.



9. OPEN THE DRINKING TAP - Let water flow through the water filter to flush the Fluoride cartridge for at least **10 minutes**. (This water can be collected for plants if so desired).



10. CLOSE ISOLATING VALVE - After flushing water through the Fluoride Removal Cartridge for 10 minutes minimum, turn off the water supply, turn on the drinking water filter faucet to release any water pressure.



11. OPEN THE OTHER HOUSINGS -

Loosen the other housings using the spanner supplied and unscrew the filter housing sump.



12. INSTALL REMAINING FILTERS – Drop in new filters in the corresponding housings WITH PACKING REMOVED.

When installing the new filters, please double check that the new filter and the current filter have the same specifications.



13. CHECK O-RING & FILTER - Lubricate with food grade silicone lubricant or similar if needed. Replace O-ring if kinked or damaged (Part No: ORG-STD). It is very important the filter and O-ring are seated properly in the housing.



14. CLOSE THE HOUSING - Screw in housing sump. Tighten the housing using the spanner supplied.



15. TURN ON THE WATER - Let water flow through the water filter.



16. KEEP DRINKING TAP OPEN - After installing cartridges KEEP DRINKING TAP OPEN to flush unit for 5 - 10 minutes. During this time, check for any visible drips or leaks from connections and fittings. Then, close it.

Water may appear milky, but this is normal and is only tiny air bubbles that will clear after a short period.



17. RESET LED INDICATOR - Reset LED indicator by following instructions on page 12.



18. CHECK FOR LEAKS – Check for leaks rectifying any before leaving the unit. Ensure that all the connections, fittings, and housings have been tightened properly.



Since new filters have been installed, pay special attention to the gap where the housings seal.

19. IF LEAKS OCCUR - If you find any drips or moisture, mark the location. This will help you locate the issue if you need to shut off the water and drain the system for repairs.

20. REMEDIATION - If you detect a leak, shut off the water supply to the RO system immediately.



21. TIGHTEN HOUSINGS, FITTINGS OR CONNECTIONS - If tightening doesn't stop the leak, you may need to replace the faulty component or fitting, or consider using plumber's tape for threaded connections. If this occurs, please contact us on 1300 70 1300.



22. FINAL CHECK - Once you have addressed any issues, turn the water supply back on and monitor for another 1-2 hours to ensure that there are no further leaks.



FAUCET INSTALLATION PROCEDURE

Figure 5 – Faucet Installation Diagram

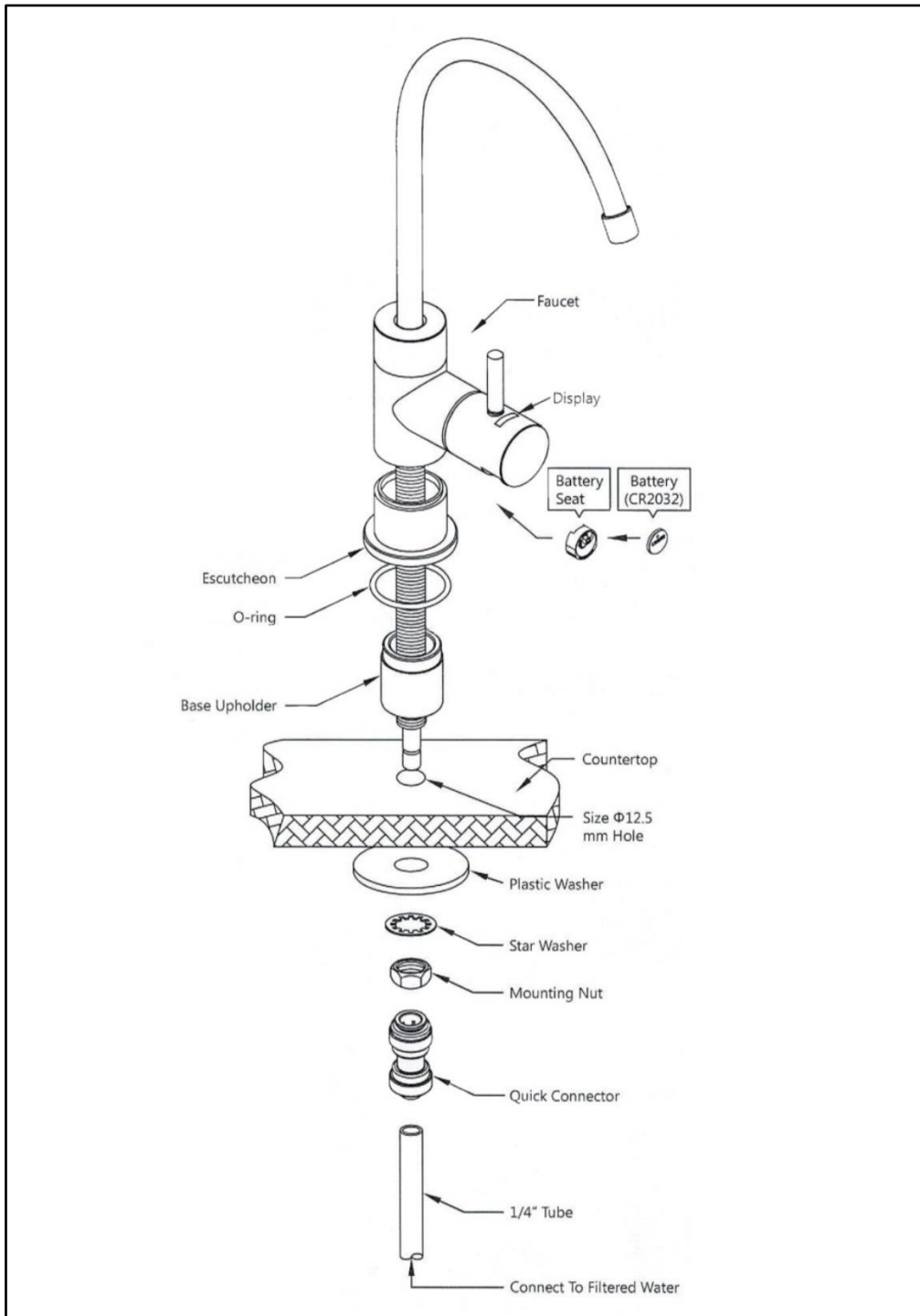

BATTERY INSTALLATION

1. **Remove** the black battery seat from the faucet lever handle.

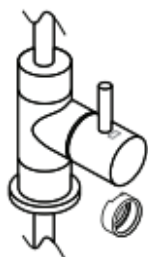

2. **Install battery** into the battery seat, positive side up, discard plastic insert.

Note: Keep your hands dry before installing or replacing the battery of the led to prevent the led circuit board from water or moisture damage.

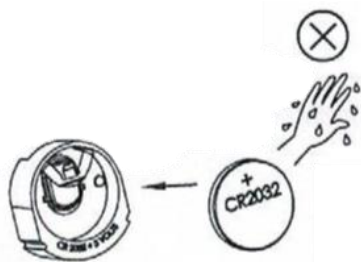

3. **Reset:** When installing or replacing battery, it will flash three times.



4. **Reinstall battery seat assembly** into the faucet lever, battery side facing outwards. The slotted end must be oriented toward the faucet.

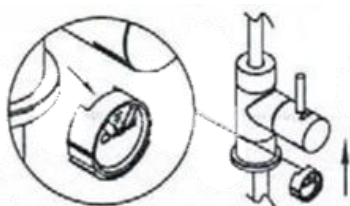

5. **Open filtered water** with blue signal 5 times only.



BATTERY REPLACEMENT & RESET

1. **AFTER ONE YEAR** - When the light flashes RED indicates your cartridges are due to be changed (usage has exceeded 3,000 minutes or 12 months).

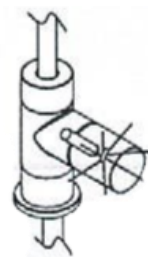

2. **Remove** the black battery seat from the faucet lever handle.

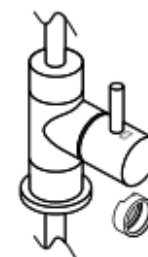

3. After one year When changing cartridges, please **replace the battery**.

Note: Keep your hands dry before installing or replacing the battery of the led to prevent the led circuit board from water or moisture damage.

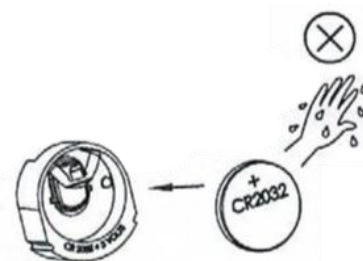

4. After replacing the battery, press the **RESET button** and hold for 5 seconds until it flashes RED-BLUE-RED.

RESET Button

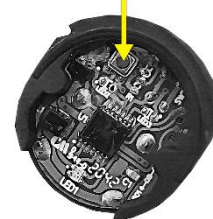

5. **Reinstall battery seat assembly** into the faucet lever, battery side facing outwards. The slotted end must be oriented toward the faucet.

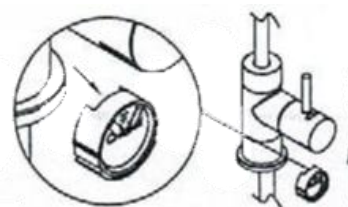

WARNING! THIS PRODUCT CONTAINS A BATTERY. ACCIDENTAL INGESTION MAY OCCUR AND CAN BE FATAL. PLEASE KEEP OUT OF REACH FROM INFANTS. IF YOU SUSPECT AN ACCIDENTAL INGESTION, PLEASE CONTACT EMERGENCY SERVICES.

LED LIGHT INDICATOR

1. After the battery is installed, **the light will flash Blue during operation**. The light will flash red after 1 year.
2. When the light flashes RED indicates your cartridges are due to be changed (usage has exceeded 3,000 minutes or 12 months). After changing the battery or replacing the cartridges, please RESET the battery.
3. At the beginning will be flashing BLUE. After 355 days will be flashing YELLOW. Then, after 365 days, will be flashing RED.
4. To RESET the battery or to program 365 days (1 year): Press for 5 seconds until flashing Red – Blue – Red.

Important note: Battery must be replaced and RESET when changing cartridges.

FAUCET MAINTENANCE AND CARE

Occasional cleaning of aerator is recommended.

1. Use of soapy water and a soft sponge or cloth is recommended.
2. Avoid cleaning with chemicals, solvents or harsh elements. (THIS MAY SERIOUSLY HARM SURFACE AREA)
3. If used with hard water or water with high mineral content, it is absolutely necessary to clean and dry the faucet immediately after every use. (CALCIUM AND OTHER MINERALS COULD SERIOUSLY DAMAGE SURFACE AREA)
4. Please wipe the canopy and keep your hands dry before installing or replacing the battery of the LED to prevent circuit board from water or moisture damage.
5. When installing with filtration system with carbon filters or changing carbon filters, it's suggested to flush the filtered tubes from the system before connecting with the faucet to prevent possible carbon dust contamination into faucet cartridge to cause leaking.

GUIDE TO USE PUSH-IN TUBE CONNECTORS

Figure 6

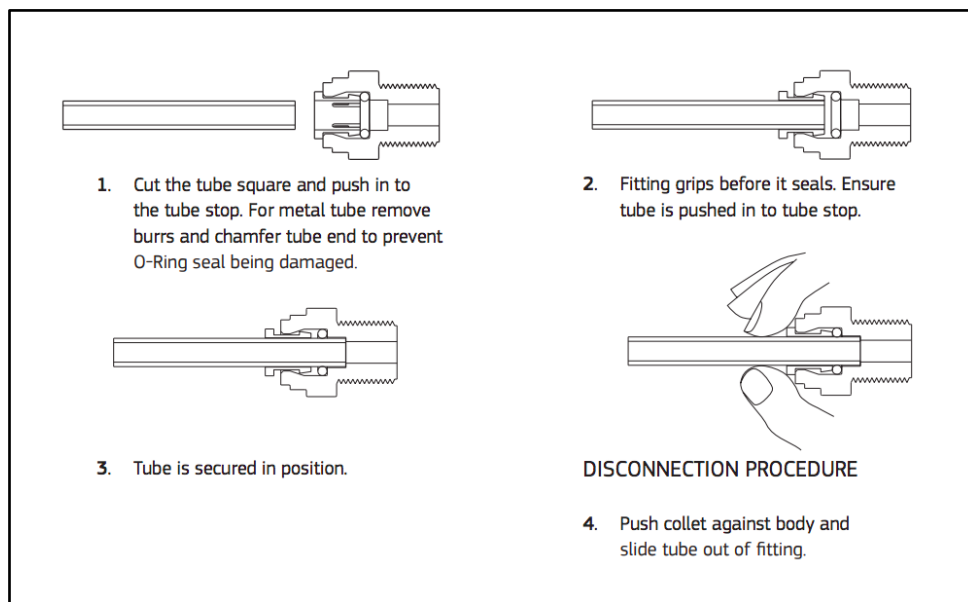

USE GUIDELINES

- Minimum operating pressure 200 kPa.
- Maximum operating pressure 520 kPa.
- Do not allow exposure to temperatures below 0°C.
- Maximum operating temperature 38°C.
- Nominal flow rate 4 Lpm.
- This system must be installed according to local plumbing codes on the cold-water line.
- Replacement Cartridges: See Cartridge replacement section (See pages 15 and 16).
- This system requires regular replacement of the filter cartridge to maintain proper operation. Varying chlorine, sediment, or organic substance levels may affect replacement frequency.
- Be sure to change the filter cartridge at least every 12 months; or whenever you detect a change in taste, odour, or decrease in flow.
- **When replacing cartridge, ensure you reset the LED reminder light by removing/replacing the battery from the rubber seat. Please refer to page 12 for a detailed diagram.**

Caution: Do not use with water that is microbiologically unsafe or of unknown quality without adequate disinfection before or after the system.

CARTRIDGE REPLACEMENT GUIDE FOR TWIN UNDERSINK SYSTEMS

You can obtain replacements from your local AquaCo dealer. To maintain performance, warranty and standards use genuine AquaCo replacements.



AquaCo 9" x 2.5" Sediment and Carbon Replacement Filters
Set of replacement filter cartridges for the 1st, and 2nd stage of the AquaCo Twin Undersink water filtration system.

*WORK FOR CITY WATER/TOWN WATER.

SKU: REP-925SC



AquaCo 9" x 2.5" Fluoride and Aragon Replacement Filters
Set of replacement filter cartridges for the 1st, and 2nd stage of the AquaCo Twin Undersink water filtration system.

*WORK FOR HARD WATER, CITY WATER, WELL WATER AND TANK WATER.

SKU: REP-925FA



AquaCo 9" x 2.5" Sediment and Aragon Replacement Filters

Set of replacement filter cartridges for the 1st, and 2nd stage of the AquaCo Twin Undersink water filtration system.

*WORK FOR HARD WATER, CITY WATER, WELL WATER AND TANK WATER.

SKU: REP-925SA

TO MAINTAIN THE HIGH QUALITY OF THE PURIFIED WATER THE CARTRIDGE(S) NEED CHANGING EVERY 6-18 MONTHS (THIS IS DEPENDENT ON WATER QUALITY AND USAGE). YOU CAN OBTAIN REPLACEMENT CARTRIDGES FROM YOUR LOCAL AQUACO STOCKIST. TO MAINTAIN PERFORMANCE AND WARRANTY USE GENUINE AQUACO REPLACEMENTS.

CARTRIDGE REPLACEMENT GUIDE FOR TRIPLE UNDERSINK SYSTEMS

You can obtain replacements from your local AquaCo dealer. To maintain performance, warranty and standards use genuine AquaCo replacements.



AquaCo 9" x 2.5" Sediment and Carbon Replacement Filters
Set of replacement filter cartridges for the 1st, 2nd and 3rd stage of the AquaCo Triple Undersink water filtration system.

*WORK FOR CITY WATER/TOWN WATER.

SKU: REP-925SCC



AquaCo 9" x 2.5" Sediment, Fluoride and Carbon Replacement Filters
Set of replacement filter cartridges for the 1st, 2nd and 3rd stage of the AquaCo Triple Undersink water filtration system.

*WORK FOR CITY WATER/TOWN WATER.

SKU: REP-925SFC



AquaCo 9" x 2.5" Sediment, Fluoride and Aragon Replacement Filters
Set of replacement filter cartridges for the 1st, 2nd and 3rd of the AquaCo Triple Undersink water filtration system.

*WORK FOR HARD WATER, CITY WATER, WELL WATER AND TANK WATER.

SKU: REP-925SFA

TO MAINTAIN THE HIGH QUALITY OF THE PURIFIED WATER THE CARTRIDGE(S) NEED CHANGING EVERY 6-18 MONTHS (THIS IS DEPENDENT ON WATER QUALITY AND USAGE). YOU CAN OBTAIN REPLACEMENT CARTRIDGES FROM YOUR LOCAL AQUACO STOCKIST. TO MAINTAIN PERFORMANCE AND WARRANTY USE GENUINE AQUACO REPLACEMENTS.

PERFORMANCE DATA SHEET

PRODUCT CODE: PP-925-1

SEDIMENT FILTER

Micron Rating	Triple Gradient: 10 µm outer (nominal), 5 µm middle (nominal), 1 µm inner (nominal)
Filter Dimensions	9" x 2.5"
Media Type	100% Polypropylene

PRODUCT CODE: CB-925-1POP

CARBON FILTER

Micron Rating	>99% @ 1 µm (Nominal)
Filter Dimensions	9" x 2.5"
Initial_P	>5.0 psid @0.75 gpm
Carbon Weight	0.80 lbs.
Carbon Type	Activated Coconut Shell Carbon

PRODUCT CODE: FL-925-OP

FLUORIDE FILTER

Filter Dimensions	9" x 2.5" @ 5 µm (Nominal)
Fluoride Reduction >90%	2,200 L @ 0.5 gpm
Media Type	Activated Aluminum Oxide

PRODUCT CODE: ARA-925

ARAGON FILTER

Micron Rating	>100% @0.5 µm (Nominal)
Filter Dimensions	9" x 2.5"
Media Type	Polypropylene, SGS Polymers, Activated Carbon

NOTES

AquaCo water care products are designed, manufactured and supported by Water Filters Pty Ltd the name you can trust for viable and proven water solutions. The complete range of AquaCo products are developed, refined, made to meet and exceed stringent specifications for the worldwide market.

Important: Sales of products are subject to our Terms and Conditions which are available upon request. All specifications, information and photos are a guide only and are subject to change without notice. Please ring to confirm details. Warning: For correct operation of this appliance, it is essential to observe manufacturer's instructions.

WARRANTY

Any contract of sale, order, or quotation made or accepted by or on behalf of Water Filters Pty Ltd (trading as AquaCo Filters) is subject to these terms and conditions of sale.

- AquaCo Filters warrants AquaCo Filtration Systems to the original purchaser for a period of 5 years for Retail customers, and 2 years for Wholesale and Trade customers from the date of sale established by the date of the original invoice issued by an authorized distributor.
- AquaCo Filters warrants each new Product to be free from defects in the product for a period of 2 year from the date of retail sale established by the date of the original invoice issued by AquaCo Filters.
- AquaCo Filters reserves the right in instalment sales to grant credit for the value of any Product found to be defective under this Warranty.
- AquaCo Filters will not cover any labour charge incurred by the Buyer for the replacement or repair of any Product.
- The Buyer is responsible for freight and local labour charges for Products the subject of this Warranty.
- This Warranty applies only to the original purchaser of the Product.
- AquaCo Filters' obligation under this Warranty is limited to AquaCo Filters' own option, to either repair or replace the Product, once AquaCo Filters has deemed that the Product is defective or AquaCo Filters may, at its own discretion, refund to the Buyer the purchase price paid for the defective goods.
- This Warranty does not cover any Product that is relocated from the site of its original installation.
- All replaced or exchanged parts taken out under this warranty become the property of AquaCo Filters.
- This Warranty is subject to the Product being properly installed, maintained, being used for its intended purpose and operated strictly in accordance with AquaCo Filters' recommendations and installation guide.
- This Warranty does not extend to a Product that has been modified in any way unless with AquaCo Filters' express consent.
- This Warranty does not cover the normal wear and tear of the Product, or damage caused by misuse, abuse or vandalism. The Warranty does not cover any malfunction or failure resulting from neglect, use of unauthorised parts and accessories or use with higher water pressure than indicated on the Product.
- The Warranty does not extend to damage caused by rain, fire, earthquake or other natural causes or acts of nature.
- It is expressly agreed that this shall be the sole and exclusive remedy of the Buyer stated herein, and under no circumstances shall AquaCo Filters be liable for any costs, loss, expense, damages, special damages, incidental damages or consequential damages arising directly or indirectly from the design, manufacture, sale, use or repair of the Product whether based upon warranty, contract, tort or strict liability.
- All Conditions and Warranties implied by law or statute are hereby expressly negated so far as they lawfully can be.

ACCEPTANCE AND CLAIMS

- Acceptance of the Products shall be deemed for all purposes to have taken place at the expiration from the date of each delivery.
- Any damage caused during or as a result of transit will not be the responsibility of AquaCo Filters.
- Any faulty systems must be returned with the Pressure Limiting Valve.
- In the event of a Warranty Claim, the Product must be forwarded at the Buyer's own risk and expense to AquaCo Filters, together with proof of purchase.
- This limited Warranty is void if the Product under Warranty is presented without the said original invoice.
- AquaCo Filters may request that a Statement accompany the Original Invoice, signed by the Buyer, setting out the following terms:
 - The name and address of the Buyer.
 - The date and by whom the Product was purchased.
 - The date and by whom the Product was installed.
 - The location where the Product was installed.
 - The date and time the Product first appeared to malfunction.
 - The nature of the problem with the Product.
 - The date and time of any and all loss event/s.
 - The date and time AquaCo Filters was first notified of the Product malfunction.
- A failure by the Buyer to submit the said Statement within 28 days, after such request is made by AquaCo Filters, will automatically void the Warranty.
- A failure to answer truthfully or to answer in a way that is misleading, entitles AquaCo Filters to void the Warranty and to notify the police in the event of suspected fraudulent conduct.

RISK

- The risk in the Product will pass to the Buyer immediately upon the Product leaving AquaCo Filters' premises for delivery to the place designated by the Buyer.

RETENTION OF TITLE

- AquaCo Filters will retain title to (but not risk in) a Product delivered to the Buyer until AquaCo Filters has received payment in full for such Product from the Buyer.
- The Buyer will store the goods in such a way as to enable them to be separately identified and will keep them insured at its own expense with AquaCo Filters' interest noted on any such insurance cover.
- If the Buyer fails to make any payment when due or becomes bankrupt or becomes insolvent, or has a judgement entered against it in any Court or enters into any scheme of arrangement, composition, or assignment or is in receivership or voluntary administration or liquidation, the Buyer grants AquaCo Filters the license to enter any of the Buyer's premises where the Product is stored, and without notice, to re -take possession of and remove, at the Buyer's cost and expense, the Product in respect of which title has not passed to the Buyer.

RIGHTS FORFEITED

The Buyer forfeits any right or claim against AquaCo Filters warrantee if:

1. The System is operated with a water temperature higher than 38° Celsius.
2. The System is not serviced every 12 months. i.e. replacement of filters, PLV check and assessment of general condition of the system. If the drinking water quality is poor, the System should be serviced before 12 months.
3. The System damage results from water hammer, freezing, neglect or is not installed by a licensed plumber in accordance with the AS3500 plumbing code and installation plan.
4. The System is subject to water pressure that exceeds the maximum recommended pressure.
5. The System is not installed with an Australian Standards approved Pressure Limiting and Dual Check Valve.
6. The System has been found to be tampered with or if the goods have not been operated or maintained strictly in accordance with AquaCo Filters' recommendations.
7. The System is not turned off when the residents are away for over 24 hours.

PRICE

- The price charged shall be AquaCo Filters' price ruling at the date of delivery unless otherwise agree in writing. Any price indications or price lists are subject to alterations to AquaCo Filters' price ruling at the date service or goods are supplied.
- Prices are as per AquaCo Filters' wholesale unless otherwise agreed in writing.
- The Buyer is responsible to effect and meet the costs of any insurance cover that is deemed necessary.
- Clerical errors in computations, typing or otherwise of "catalogue, quotation, acceptance, invoice, delivery docket or other document" shall be subject to correction.
- Any goods returned through no fault of AquaCo Filters will be subject to a 15% restocking fee.

DEFAULT

On the happening of any one or more of the following events, namely:

- The Buyer fails to make payment to AquaCo Filters on the due date;
- An administrator or liquidator is appointed over any or all of the assets of the Buyer or a scheme of arrangements is proposed to approve with respect to the Buyer;
- In the case of the Buyer being a natural person, the Buyer commits an act of bankruptcy; then AquaCo Filters may at its option exercise all or any of the following rights (notwithstanding any prior failure to exercise such rights):
 - a. demand payment of the whole of the monies owing from the Buyer to AquaCo Filters and the Buyer agrees to pay the same immediately.
 - B. the Buyer shall pay to AquaCo Filters interest on such amount outstanding at the rate of 2% per month and any costs with respect to solicitors, legal advisors, mercantile agents and other agents acting on behalf of AquaCo Filters in respect of any enforcement hereof or recovery or attempted recovery of monies owing by the Buyer to AquaCo Filters.

SEVERENCE

If any of these terms or conditions become for any reason wholly or partly invalid, that term or condition shall to the extent of the invalidity be severed without prejudice to the to the continuing force and validity of the remaining terms and conditions.

JURISDICTION

AquaCo Filters and the buyer agree that this agreement and its provisions shall be construed in accordance with the laws of the State of Western Australia and be resolved by a Western Australian Court.

WARRANTY/AUSTRALIA

This warranty is given by Water Filters Pty Ltd, ABN 68618671677, telephone no. 1300 70 1300 and email at sales@waterfilter.com.au.

This warranty is provided in addition to other rights and remedies you have under law: Our goods come with guarantees which cannot be excluded under the Australian Consumer Law. You are entitled to replacement or refund for a major failure and to compensation for other reasonably foreseeable loss or damage. You are also entitled to have the goods repaired or replaced if the goods fail to be of acceptable quality and the failure does not amount to a major failure.



NOTES

A series of horizontal blue lines provided for taking notes during the installation process.

ABOUT US



Welcome to AquaCo, your trusted partner in water filtration solutions. With over 13 years of dedicated service and a combined experience exceeding 30 years in the water filtration industry, we are proud to have been at the forefront of purifying Australia's water supply. Our mission is simple: to ensure that every Australian has access to the purest water possible.

As a nation-wide leader in water filtration, our reach extends across the entire country. From bustling cities to remote communities, we seamlessly supply and install state-of-the-art filters wherever needed, guaranteeing clean and safe drinking water for all.

At AquaCo, quality is our unwavering commitment. That's why we import premium components from around the globe and assemble our filtration systems in two of Australia's iconic cities: Perth and Sydney. This dual-location operation allows us to cater to diverse needs while maintaining the high standards our customers expect.

We understand the importance of safety and reliability, which is why we only collaborate with licensed plumbers and utilize certified and world-wide tested components in every installation. With our cutting-edge technology, you're not just investing in a filtration system; you're investing in years of research, innovation, and absolute excellence.

Thank you for choosing AquaCo for your water filtration needs. Together, let's ensure a healthier, happier future with clean, pure water for all Australians.

Regards,

AquaCo Filters Team

For the latest information, updates, and to stay informed about water filtration news and cutting-edge technologies, be sure to follow us on:

